

Precision Test Adapters

1.85 mm(F) to 2.4 mm(F)

Withwave's Precision Test Adapters are designed based on precision microwave interconnection technologies.

This 1.85 mm(F) to 2.4 mm(F) adapter is manufactured to precise microwave specifications and constructed with female gender on side 1 and female gender side 2.

The precision microwave connector interfaces ensure an excellent microwave performance up to 50 GHz



■ Features

- Frequency range : DC to 50 GHz
- VSWR : 1.20 : 1(Max) @ 50 GHz
- Stainless steel (passivated)

■ Specification

Scope	Specification	AD01F02FS1
Electrical	Impedance(Ohm)	50
	Operation Freq.(GHz)	DC to 50 GHz
	VSWR (Max)	1.20 : 1
Material	Dielectric	Special dielectric
	Center Contact	Brass with gold plated
	Body	Passivated Stainless Steel

* RoHS Compliant

Precision Test Adapters

1.85 mm(F) to 2.4 mm(F)

withwave

Versatile RF & MW Test Solutions

■ Drawing

Part No.: AD01F02FS1

Unit : mm

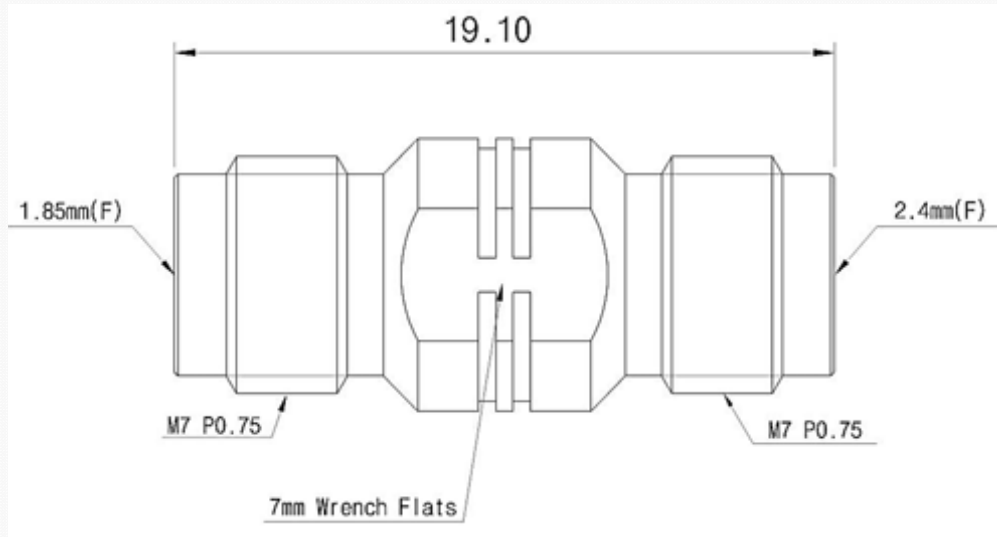

■ Test Result

▪ Frequency : 10 MHz to 50 GHz

