

WS408NKU is an absorptive SP4T RF switch module that supports a frequency range from 10 MHz to 10 GHz. It delivers high isolation, low insertion loss and fast switching time, making this device ideal for RF signal routing in wireless infrastructure and wireless applications up to 10 GHz. External connectors include 2.92mm-vertical launch connector for all RF port.

WS408NKU is powered and controlled through USB type-C connector.



■ Features

- CMOS SOI technology enhanced
 - Broadband 10 MHz~10 GHz
 - Fast settling time
- High power handling of 33 dBm THRU path
- Insertion loss
 - 3.4 dB @ 10 GHz
- High isolation
 - 33 dB up to 10 GHz

■ Applications

- Test & Measurement
- 5G Wireless Communication
- Commercial Communication
- RF signal routing

Electrical Specifications

Parameter	Path	Condition	Min	Typ	Max	Unit
Operation Frequency			10 MHz		10 GHz	
Insertion loss	All path	10 MHz ~ 10 GHz		3.4		dB
Return loss (common port)	All path	10 MHz ~ 10 GHz	10.0	11.0		dB
Return loss (active port)	All path	10 MHz ~ 10 GHz	11.0	12.3		dB
Return loss (isolated port)	All path	10 MHz ~ 10 GHz	11.0	13.0		dB
Isolation	All path	10 MHz ~ 10 GHz	30.0	33.0		dB
RF Input Power	All path	10 MHz ~ 8 GHz		33.0		dBm
0.1 dB Power Compression	All path	f = 100 MHz to 8 GHz		35.0		dBm
Input IP3	All path	100 MHz ~ 8 GHz		60.0		dBm
Switching Time		COM port control time @Window10		200		us
Current consumption		USB type-C		14.0		mA
Power Supply		USB type-C		5.0		V
Baud Rate		USB COM port		115200		bps
RF Connectors		2.92mm-female				
ESD HBM		RF port USB port		1.0k 16k		V
Operating Temperature			-40		105	°C

Typical Performance Data

< Insertion Loss >

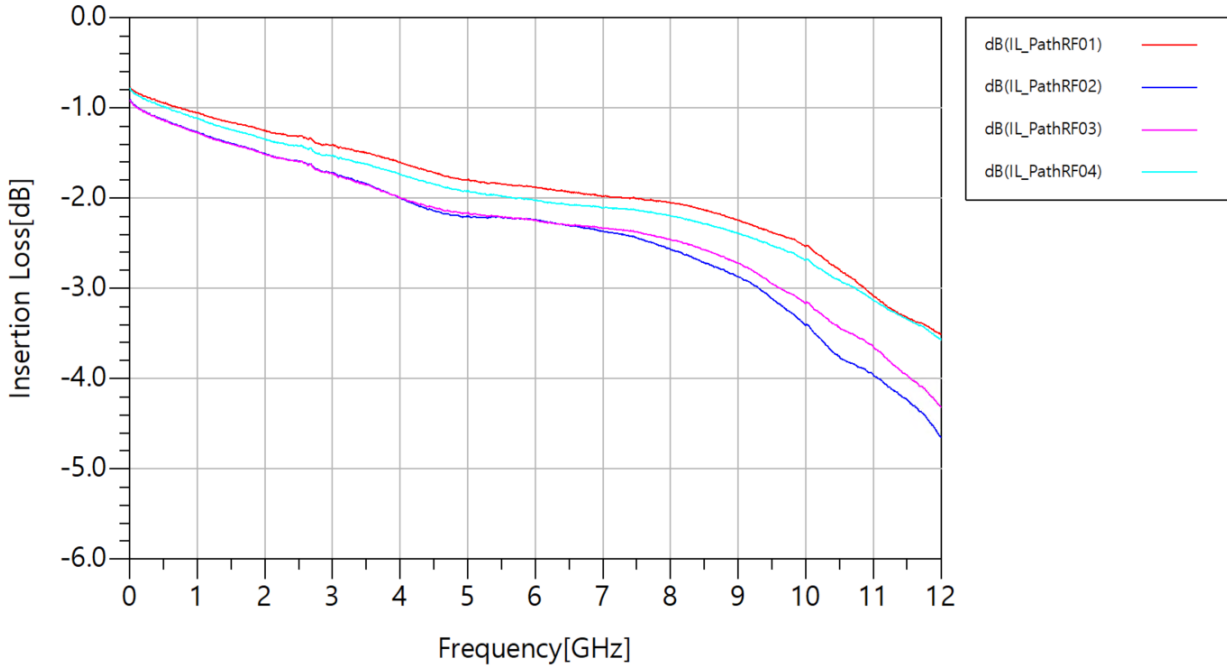

< Common Port Return Loss >

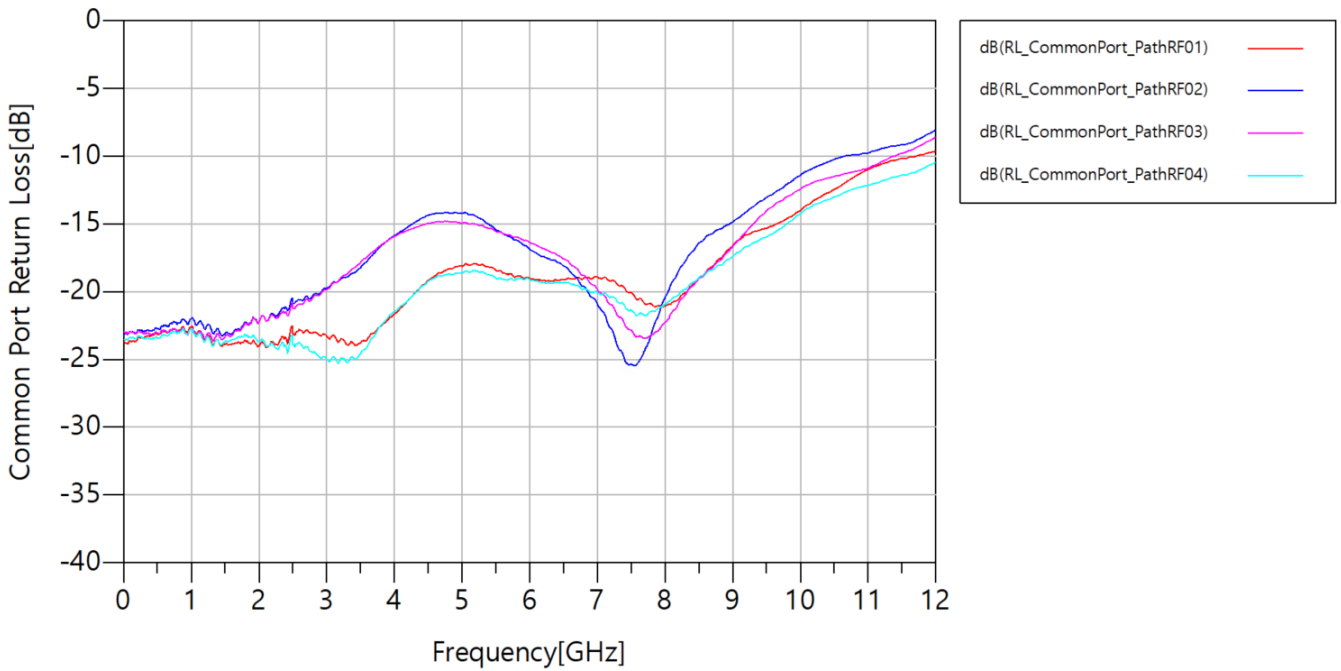

■ **Typical Performance Data**

< Active Port Return Loss >

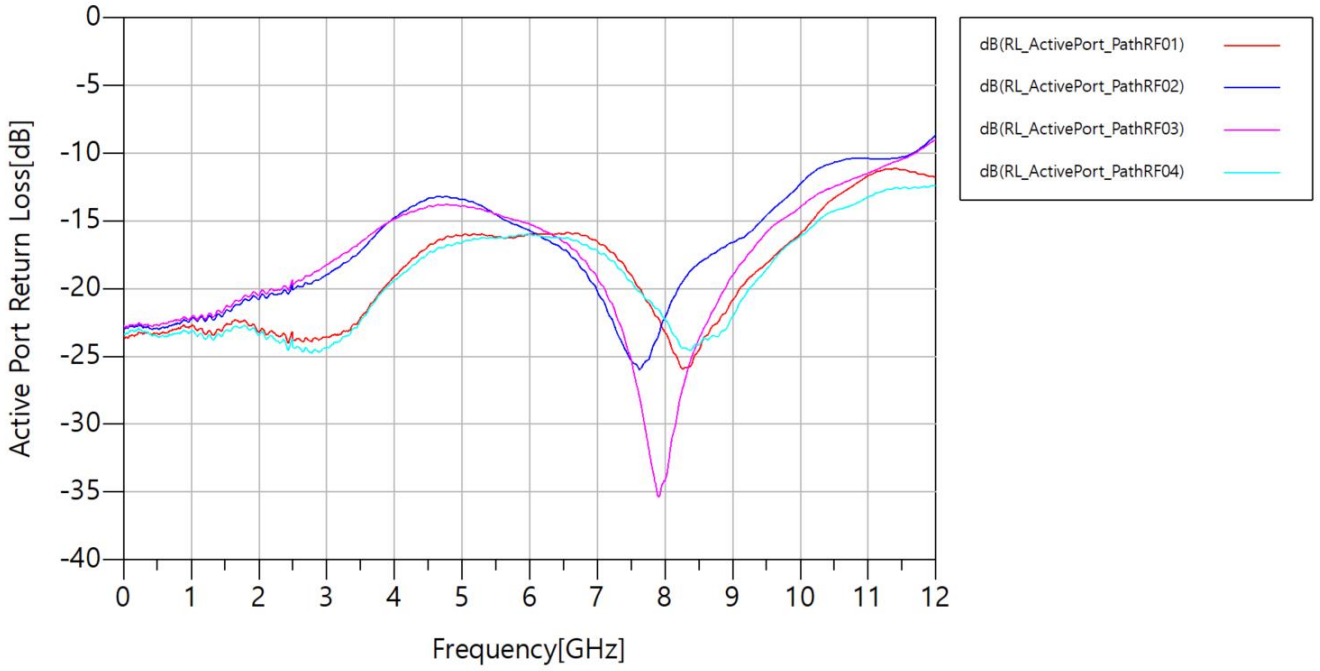

< Isolated Port Return Loss >

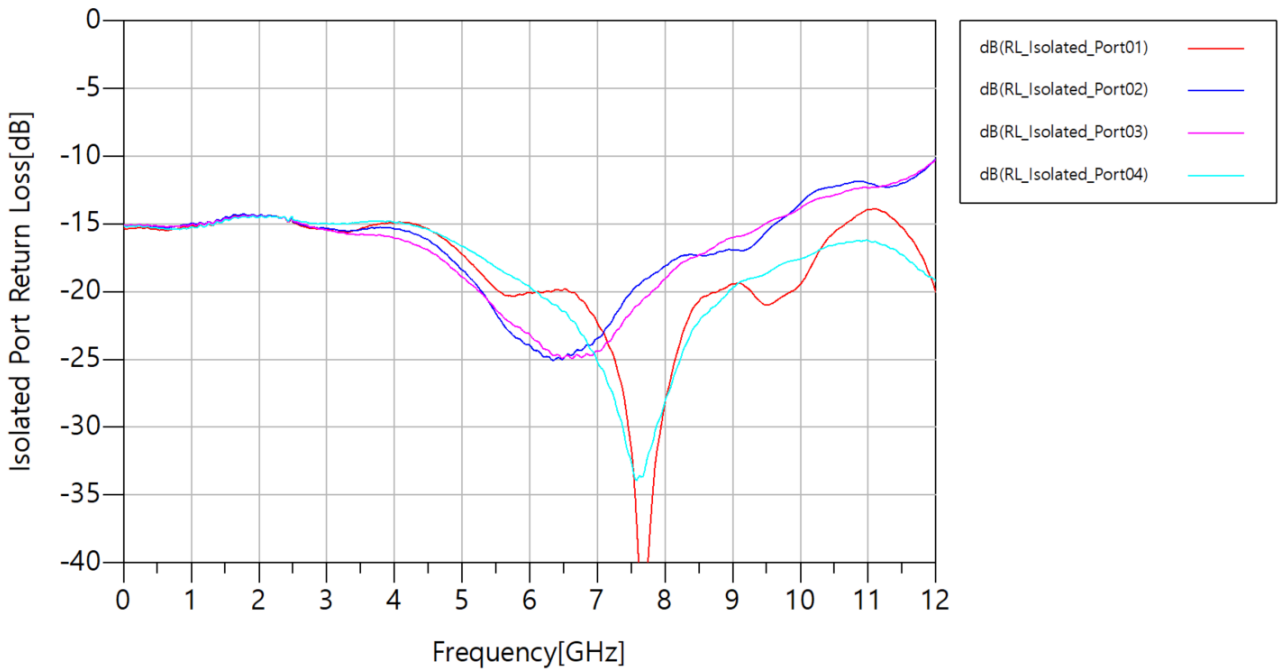

Typical Performance Data

< RFC to RFx Isolation @ PathRF01 >

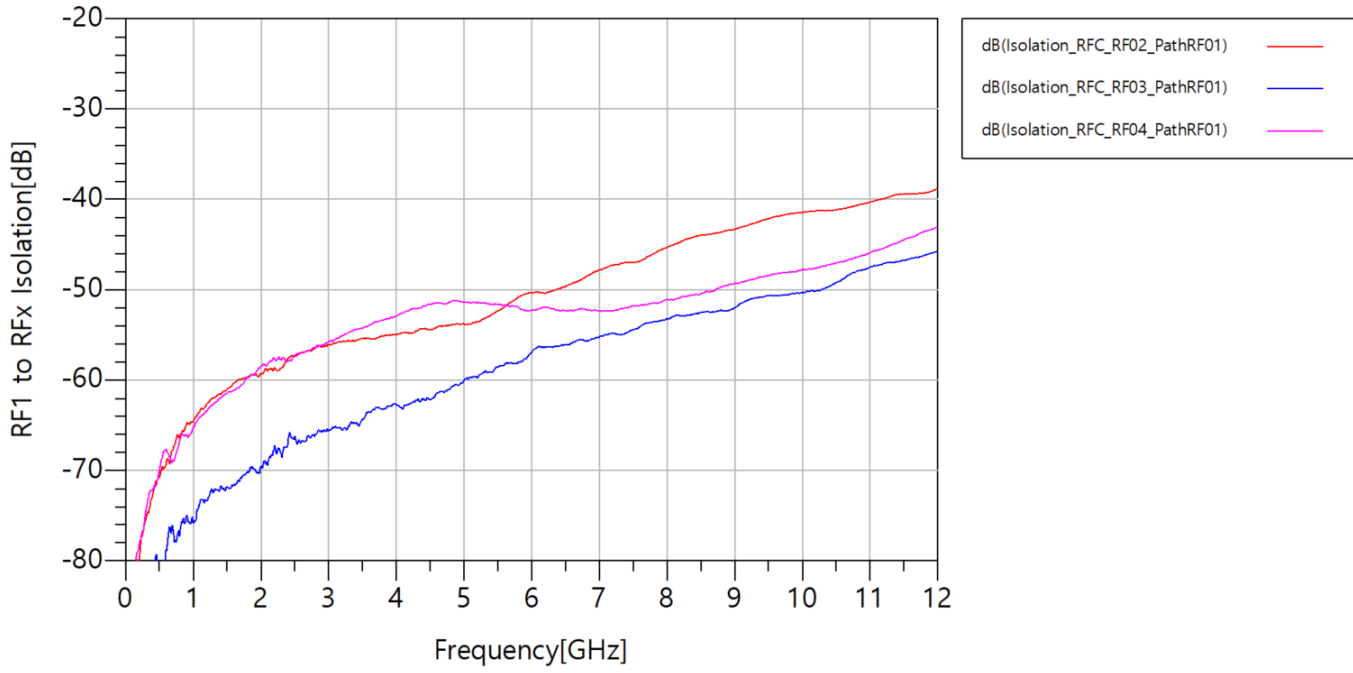

< RFC to RF01 Isolation @ PathRFx >

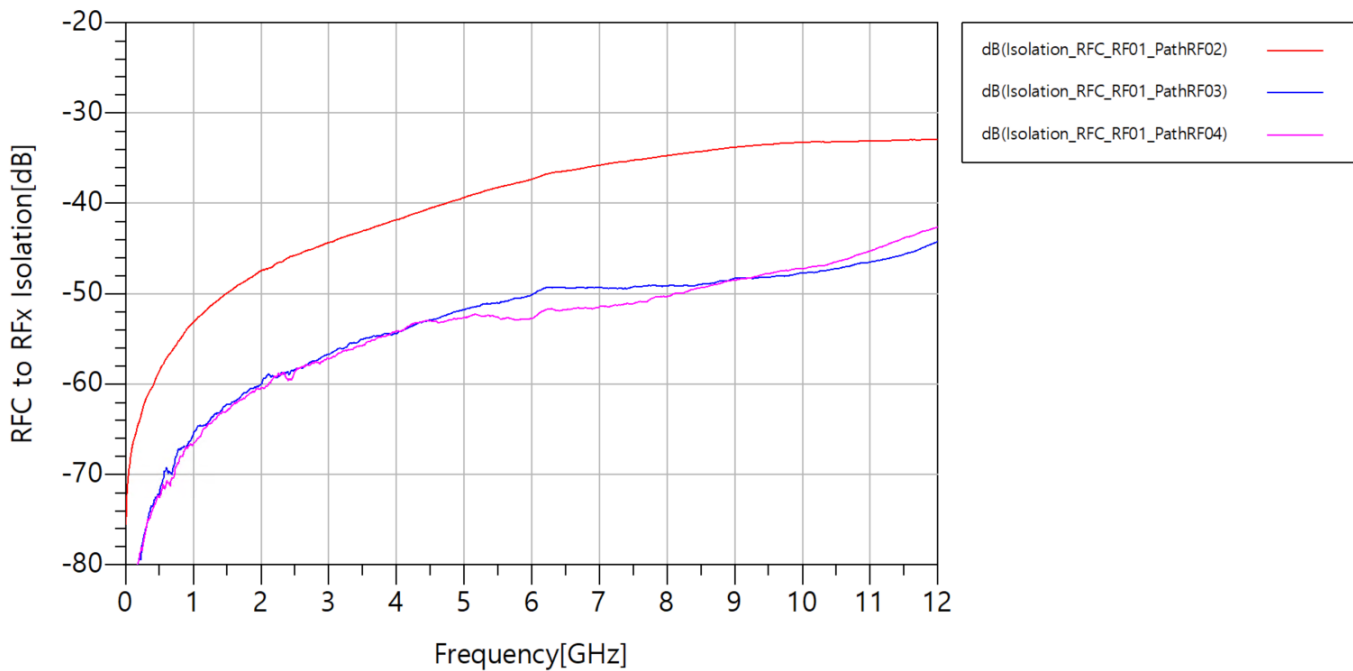

■ Dimension

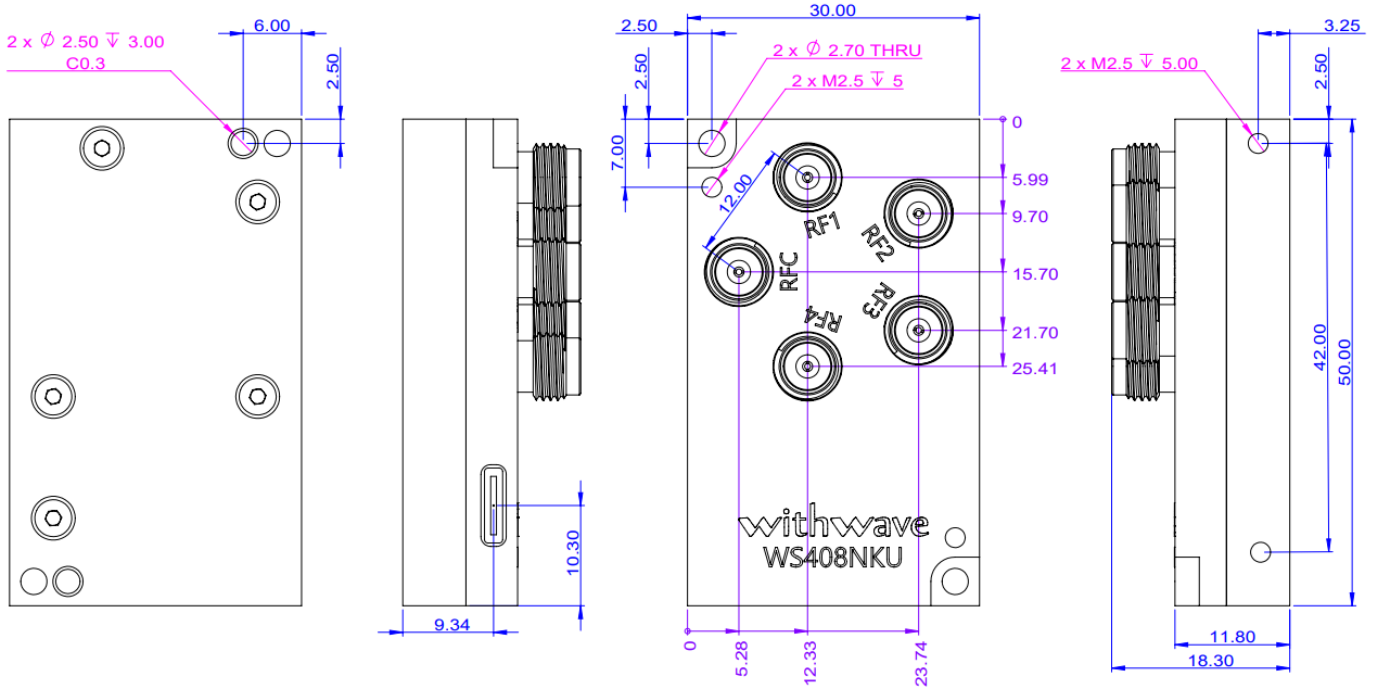

■ **Control Description**

Command Format	COM port configuration
All commands must end with a semicolon. All commands are capitalized only. Port number should be 2-digit decimal.	Baud Rate :115200 Data bits : 8 Parity : None Stop bits : 1 Flow Type :None

■ **Command Specification**

Index	Command	Description	Return	Example
1	*IDN?;	Query product information	Product PN, Manufacturer , WS408NKU, Withwave SW version, Serial number co, Ltd., V1.0, SN0001	
2	RESET;	Reset the product	RESET;	RESET;
3	Pxx;	Switching to RFC to RFxx Port number should be 2-digit decimal	Pxx;	P02;
4	OFF;	All off state	OFF;	OFF;

■ **Error Code**

Index	Return	Description
1	E1;	Semicolon missing
2	E2;	Incorrect commands

■ Revision History

Revision	Date	Changes
Ver 1.0 Ver 1.1	2022-06-02 2023-05-31	Initial work Add switching time