

# Precision Test Adapters

## 1.85 mm(F) to 2.92 mm(F)

**withwave**

Versatile RF & MW Test Solutions

**Withwave's Precision Test Adapters** are designed based on precision microwave interconnection technologies. This 1.85 mm(F) to 2.92 mm(F) adapter is manufactured to precise microwave specifications and constructed with female gender on side 1 and female gender side 2. The precision microwave connector interfaces ensure an excellent microwave performance up to 40 GHz



### ■ Features

- Frequency range : DC to 40 GHz
- VSWR : 1.10 : 1(Max) @ 40 GHz
- Stainless steel (passivated)

### ■ Specification

Scope	Specification	AD01F03FS1
Electrical	Impedance(Ohm)	50
	Operation Freq.(GHz)	DC to 40 GHz
	VSWR (Max)	1.10: 1
Material	Dielectric	Special dielectric
	Center Contact	Brass with gold plated
	Body	Passivated Stainless Steel
	Operating Temperature	-65 to +165 °C

\* RoHS Compliant

### ■ Drawing

**Part No.: AD01F03FS1**

Unit : mm

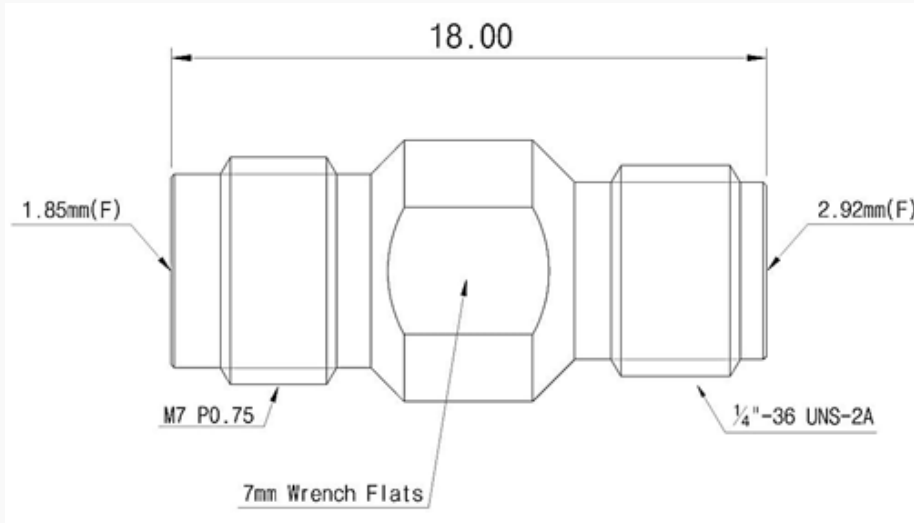

### ■ Test Result

- Frequency : 10 MHz to 40 GHz

